

CL200 2V 200Ah(10hr)



The rechargeable batteries are lead-lead dioxide systems. The dilute sulfuric acid electrolyte is absorbed by separators and plates and thus immobilized. Should the battery be accidentally overcharged producing hydrogen and oxygen, special one-way valves allow the gases to escape thus avoiding excessive pressure build-up. Otherwise, the battery is completely sealed and is, therefore, maintenance-free, leak proof and usable in any position.

Battery Construction

Component	Positive plate	Negative plate	Container	Cover	Safety valve	Terminal	Separator	Electrolyte
Raw material	Lead dioxide	Lead	ABS	ABS	Rubber	Copper	Fiberglass	Sulfuric acid

General Features

- Absorbent Glass Mat (AGM) technology for efficient gas recombination of up to 99% and freedom from electrolyte maintenance or water adding.
- Not restricted for air transport-complies with IATA/ICAO Special Provision A67.
- UL-recognized component.
- Can be mounted in any orientation.
- Computer designed lead, calcium tin alloy grid for high power density.
- Long service life, float or cyclic applications.
- Maintenance-free operation.
- Low self discharge.

Dimensions and Weight

Length(mm / inch).....173 / 6.81
 Width(mm / inch).....111 / 4.37
 Height(mm / inch).....330 / 12.99
 Total Height(mm / inch).....364 / 14.33
 Approx. Weight(Kg / lbs).....15 / 33.1

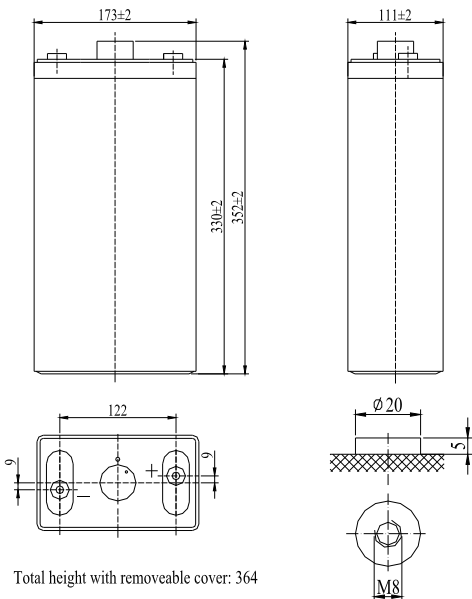

Total height with removeable cover: 364

Performance Characteristics

Nominal Voltage2V
 Number of cell1
 Design Life20 years
 Nominal Capacity 77°F(25°C)
 10 hour rate (20A, 1.8V)..... 200Ah
 5 hour rate (36.3A, 1.75V)..... 181.5Ah
 1 hour rate (124A, 1.6V)..... 124Ah
 Internal Resistance
 Fully Charged battery 77°F(25°C) 0.67mOhms
 Self-Discharge
 3% of capacity declined per month at 20°C(average)
 Operating Temperature Range
 Discharge -20~60°C
 Charge -10~60°C
 Storage -20~60°C
 Max. Discharge Current 77°F(25°C)1000A(5s)
 Charge Methods: Constant Voltage Charge 77°F(25°C)
 Cycle use 2.35-2.45V
 Maximum charging current 40A
 Temperature compensation -5.0mV/°C
 Standby use 2.25-2.3V
 Temperature compensation -3.3mV/°C

Discharge Constant Current (Amperes at 77°F25°C)

End Point Volts/Cell	10min	15min	30min	45min	1h	3h	5h	10h
1.60V	392	294	196	162	124	56.6	39.3	21.4
1.65V	372	280	187	155	120	54.8	38.4	21.2
1.70V	350	265	178	148	115	52.9	37.4	20.9
1.75V	329	250	169	141	110	50.8	36.3	20.5
1.80V	307	235	160	134	104	48.6	35.0	20.0

Discharge Constant Power (Watts at 77°F25°C)

End Point Volts/Cell	10min	15min	30min	45min	1h	2h	3h	5h
1.60V	580	524	380	308	245	146	106	78.0
1.65V	559	499	364	299	235	142	104	76.6
1.70V	538	473	348	289	224	137	101	75.1
1.75V	517	446	331	280	213	132	98.0	73.5
1.80V	495	420	315	272	201	126	94.7	71.7

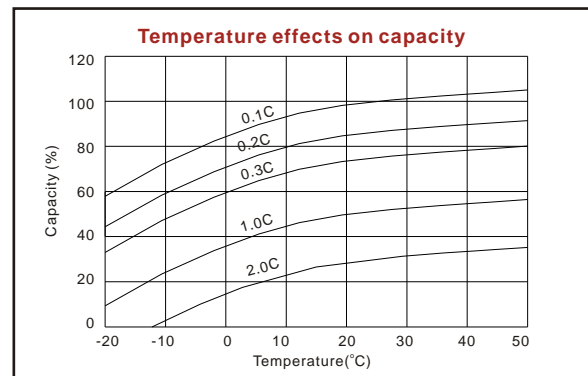
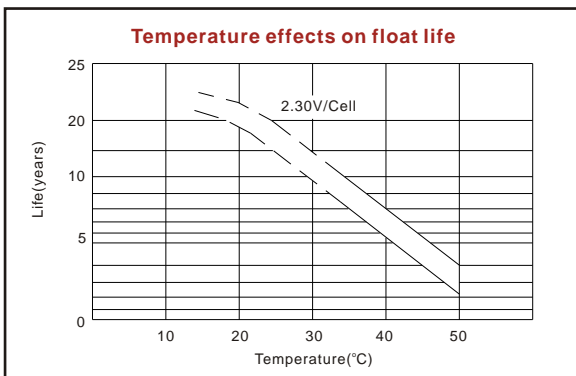
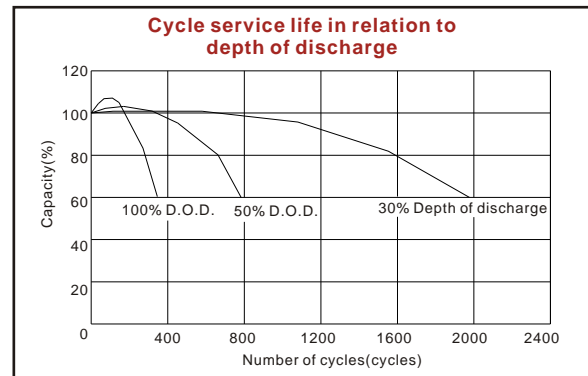
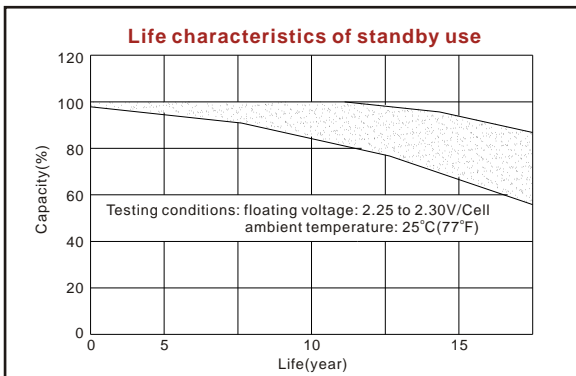
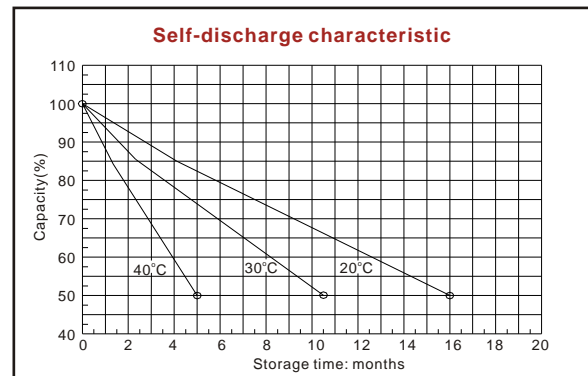
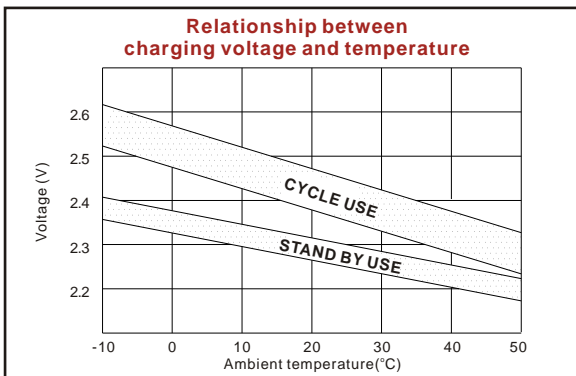
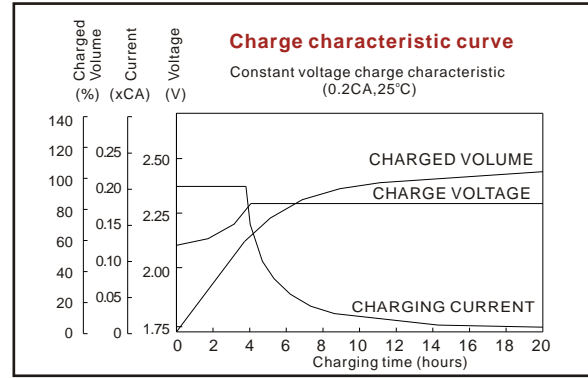
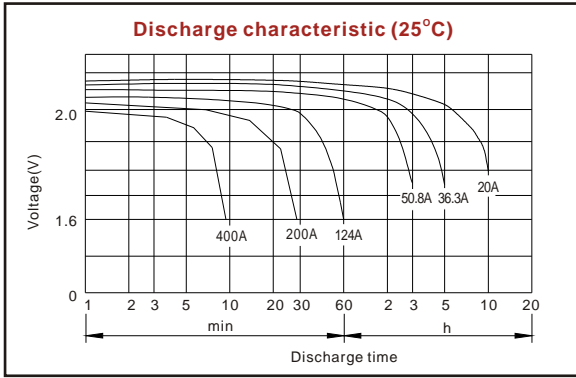

ISO9001:2000

MH25860

G4M19906-9202-E-16

www.vision-batt.com

Shenzhen Center Power Tech. Co., Ltd.
 Center Power Industrial Park, Tongfu Industrial District Dapeng Town, 518120 Shenzhen, China
 Tel: (+86-755) 8431 8088 Fax: (+86-755) 8431 8038 E-mail: sales@vision-batt.com